

Varenummer: 20146B25402BL  
 Beskrivelse: E+G  
 Flange rørholder GN 146-B25-40-2-BL

## Mål

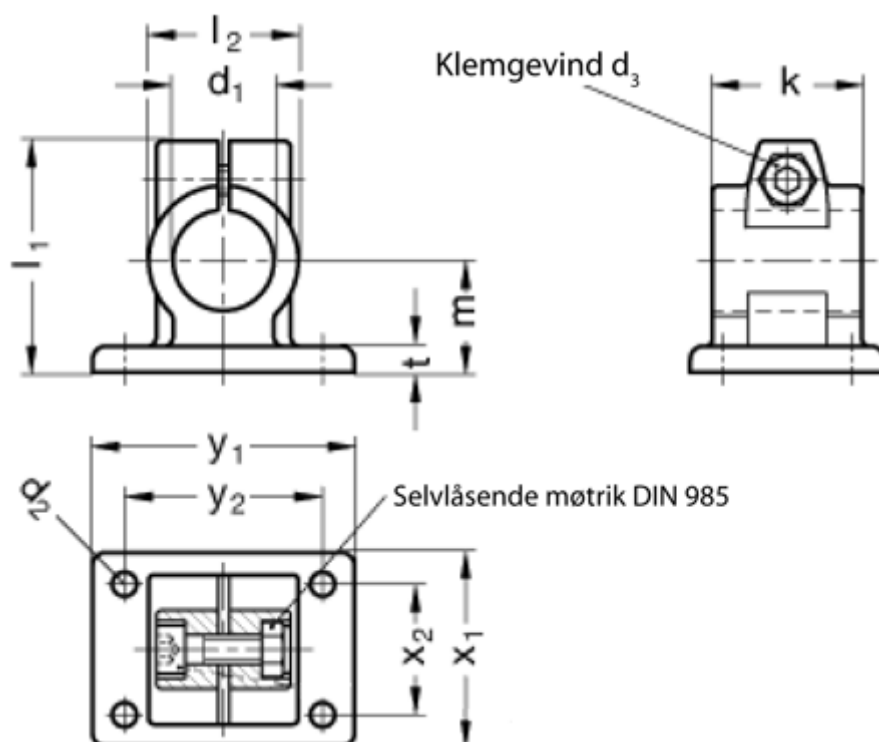

$d_1 = B25$	Vippehåndtag = GN 911-M 8-32 skal bestilles separat
$d_2 = 6.5$	$x_1 = 52$
$d_3 = M 8$	$x_2 = 35$
$k = 40$	$y_1 = 70$
$l_1 = 62$	$y_2 = 53$
$l_2 = 40$	
$m = 30$	
$t = 7$	